



High efficiency pumps

WITA Delta HE 35 | HE 55



Technical Data

Max. pump lift	4.0 m 6.0 m
Max. flow rate	2.600 l/h 3.200 l/h
Power consumption	3 - 23 W 3 - 38 W
Control	3 constant characteristics, 4 proportional characteristics, night mode
Supply voltage	1x 230V, 50 Hz
Motor protection	No external motor protection required
IP rating	IP 42
Ambient temperature	0 °C to +40 °C
Media temperature	+5 °C to +110 °C
Temperature class	TF 110 as per CEN 335-2-51
Max. system pressure	10 bar
Connection size	DN 15, DN 20, DN 25, DN 32
Installation lengths	110 mm, 130 mm, 180 mm
Pump housing material	130 mm, 180 mm variant in grey cast iron cataphoresis coated; 110 mm variant in brass
Weight incl. insulation	2.5 kg
EEI	≤0.20

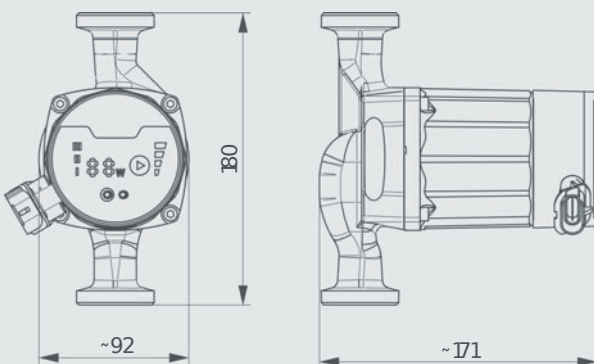
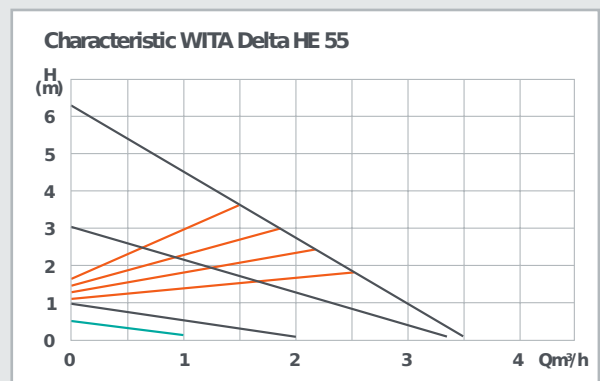
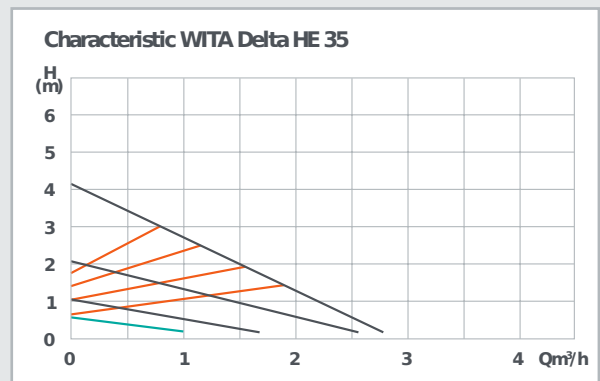



High efficiency pumps

Display

Display HE-Pumps

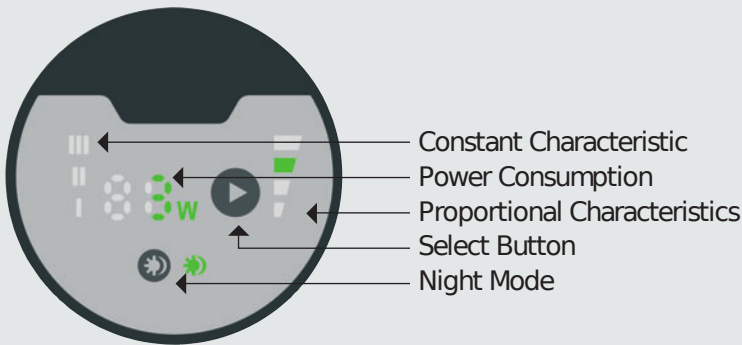

Display Delta UP, MIDI and MAXI

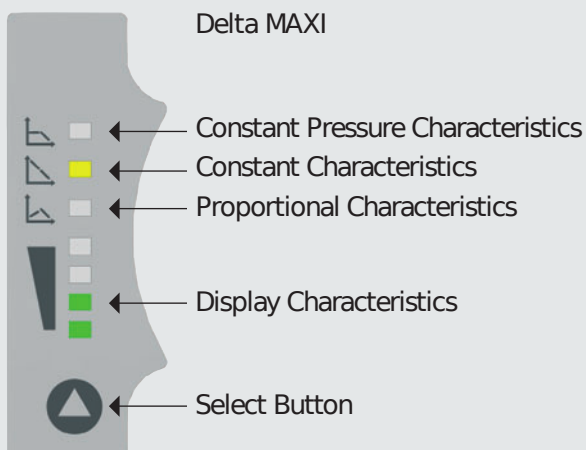
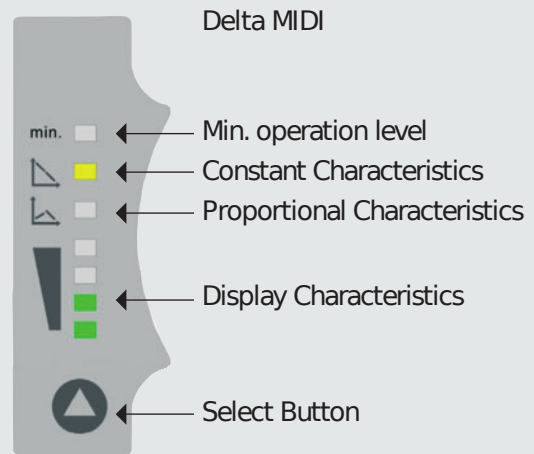
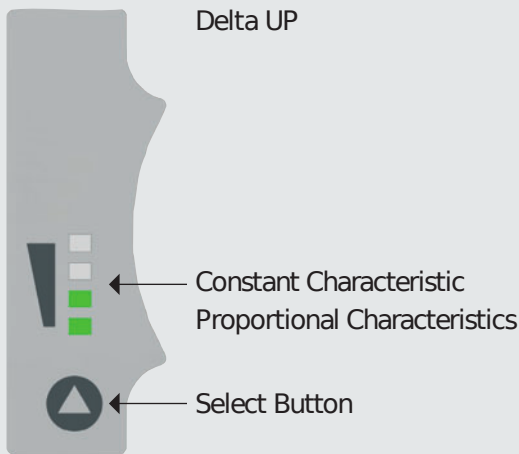

For further information as well as technical documentation for download we kindly invite you to visit our website:
www.wita-taake.de